

S Sandberg®
ACTIVE 

Survivor Radio All-in-1 2000

Quick guide

421-04



www.sandberg.world

Product overview

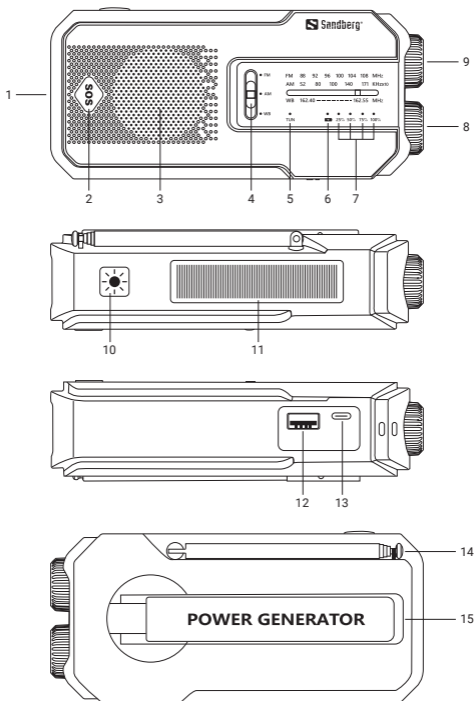

1. Lights
2. SOS Alarm button
3. Speaker
4. Band selector
5. Tuning OK indicator
6. Charging indicator
7. Battery status 25/50/75/100%
8. Tuning
9. ON/OFF & Vol+/Vol-
10. Light button
11. Solar panel
12. USB-A output
13. USB-C input
14. Retractable antenna
15. Hand crank

Charging the internal battery

Hand crank



Turn the crank at 120 - 150 rpm (2 - 2.5 times per second). 1 minute of turning can power the radio for about 3 minutes.

Approximate charging time by the hand crank (battery 0-25%): 5 hours

Solar panel

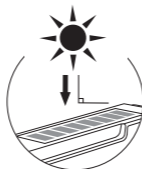

Make sure to place the solar panel in direct sunlight with no shadow.

Approximate charging time by the solar panel (battery 0-25%): 20 hours

AC charger

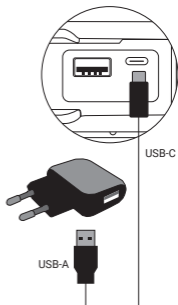

NOTE: Please only use the included USB-C to USB-A cable.

Charge device

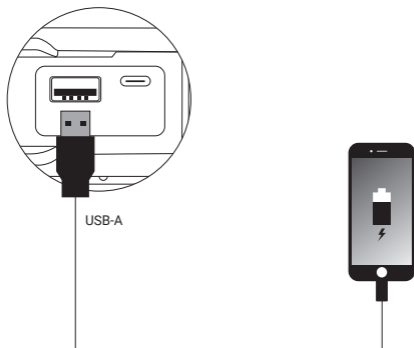

Operation

Power ON/OFF:

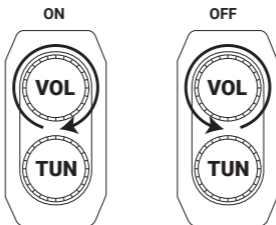

Volume setting:



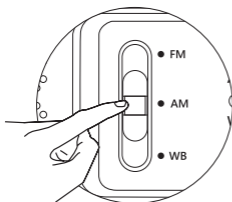

Tuning the radio:

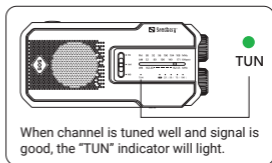
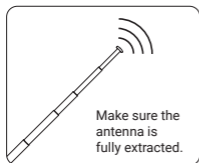
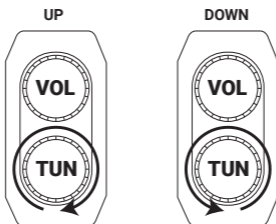

Select band FM/AM/WB
(WB Weather broadcast
channel only active in USA)

Frequency setting:

Flash Light and SOS buttons:

Button	Press	Function
	Short (toggle)	Flashlight ON/OFF
	Long (toggle)	Speaker loud signal ON/OFF

CE letter of conformity



Declaration of Conformity

Manufacturer:	Sandberg A/S
Address:	Bregneroedvej 133D, 3460 Birkerøed, Denmark
Product description:	Multi device of powerbank, AM+FM radio, speaker and lamp
Product name/Type no:	Survivor Radio All-in-1 2000 / 421-04

We declare under our sole responsibility that the products, to which this declaration relates, are in conformity with the Council Directives on the approximation of the laws of the EEC Member States relating to the following:

Directives

EMC Directive 2014/30/EU
RED Directive 2014/53/EU
RoHS Directive 2011/65/EU with amendment (EU)2015/863

And standards

EN 55032: 2015/A11: 2020
EN 55035: 2017/A11: 2020
EN IEC 61000-3-2: 2019/A1: 2021
EN 61000-3-3: 201/A2: 2021
ETSI EN 303 345-1 V1.1.1 (2019-06)
ETSI EN 303 345-2 V1.2.1 (2021-12)
ETSI EN 303 345-3 V1.1.1 (2021-06)

Date: 26th June 2024

Location: Birkerøed, Denmark

Name: Anders Petersen



Signature

Support

<http://helpdesk.sandberg.world>

Warranty

There is a five-year warranty on your Sandberg product. Please read the warranty terms and register your new Sandberg product at www.sandberg.world/warranty

5
Years
Warranty

Survivor Radio All-in-1 2000

Capacity: 2000 mAh (7.4 Wh)

USB-A output: 5V/2A, USB-C input: 5V/2A

Solar Panel Voltage: 5V, 95 mA (0.48W max)

Hand crank power: 5V, 380 mA (1.9W max)

Product weight: 260g

Item no. 421-04

www.sandberg.world

info@sandberg.world

Sandberg A/S

Bregnerødvej 133D,
3460 Birkerød, Denmark

Made in China



NOTE: For optimal battery performance, we recommend fully discharging and recharging the radio at least once every three months.

